

► DIRECT FEED



## OPERATOR'S MANUAL



### ⚠ NOTICE

Read & Understand  
Retain for Future Reference

## GENERAL SAFETY

1. Read operator's manual carefully and thoroughly. Understand all safety warnings and instructions before attempting operation of the unit.
2. Hydro 700 must be properly grounded as a precaution against possible electric shock. Always check for the correct voltage.
3. Always disconnect power before inspecting or servicing machine.
4. Keep cord away from heat, oil, sharp edges and moving parts. Replace damaged cords immediately. Damaged cords increase the risk of electric shock.
5. If use of an extension cord is necessary, use a heavy, gauge 3 wire extension cord with a molded three-prong plug (See installation).
6. Keep hands and all objects from entering the path of the blade.
7. Install the Hydro SS 700 at bench-top height or higher for added safety and optimum performance.
8. Do not use flammable liquids, caustic materials, or corrosive materials with the Hydro SS 700.
9. When servicing Hydro SS 700, use only identical replacement parts and follow instructions in the maintenance section of this manual. Use of unauthorized parts or failure to follow maintenance instructions may damage equipment or cause personal injury.



### CAUTION

***THE HYDRO SS 700 CAN BE AUTOMATED WHEN USED IN CONJUNCTION WITH A CONTROL. A FAN MAY NOT APPEAR POWERED BUT COULD SUDDENLY BEGIN HIGH-SPEED ROTATION AS A FUNCTION OF THE PRESET CONTROL.***



### NOTICE

***GROUND FAULT RECAPTACLES ARE STRONGLY RECOMMENDED AND MAY BE REQUIRED BY LAW.***

## UNPACKING

**When unpacking your unit,**

**Locate the following items:**

**1 - Direct Feed Hanging Unit**

**1 - 20-300 cc/min Flowmeter Panel**

**1 - Drainage Line 3/8" OD**

**1 - Water line with Hose Connector**

**5 - Wire Ties**

**1 - Operator's Manual**

# PLACEMENT & LAYOUT

## Placement Guidelines

Mount the fan high overhead in the largest available open area. As a general rule, the higher the better when mounting your fan. Allow one foot above the unit and adequate room in front of and below the fan for the unobstructed propulsion of the fog.



Mount the fan near the intake end of a ventilated structure. In structures with no ventilation, install the unit at the largest, most open end and propel the fog towards the opposite end.

Utilize the pivoting fogging head in order to maximize the unit's performance.

**DO NOT** Propel the fog into the wind (direction of airflow).

**DO NOT** Pivot the fogging head to propel fog at a sharp downward angle.

**DO NOT** Cramp the fan in tight spaces or skinny aisleways.

**DO NOT** Mount the fan near the ground or underneath tables or benches. This would result in a high loss of fog onto the ground, though it would not cause mechanical harm to the unit.

## Layout Guidelines

### Small structures

In applications requiring only one unit, install the unit anywhere along one end wall, propelling the fog up and horizontally down the length of the structure. If there is forced ventilation, choose the intake end of the structure. The best location for automated controls is behind the fan at an easily-accessible level for monitoring.

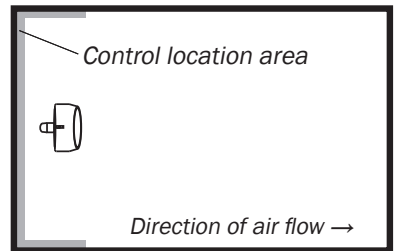

### Large structures

Equally space the units within the structure. Lower humidity and/or cooling requirements can allow for greater distance between fans. Usually, the maximum distance between fans should be 20' from the side and 35' from the front. If the structure has forced ventilation, shift the fans closer to the intake end. The fans should always be propelling their fog with the direction of natural or forced air flow.

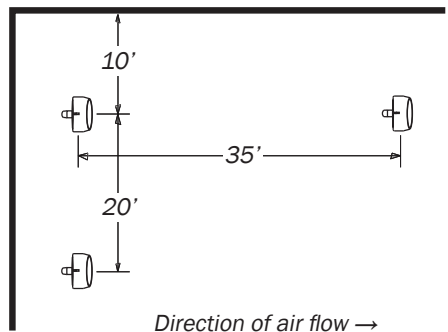

# INSTALLATION & OPERATION

## Installation

After unpacking, locate a sturdy horizontal support capable of handling over 20 pounds of weight. Drill a 5/16" clearance hole through the support where you want to hang the unit. Using 1/2" wrenches, secure the Direct Feed unit into position with hardware provided. **See Fig. 1**

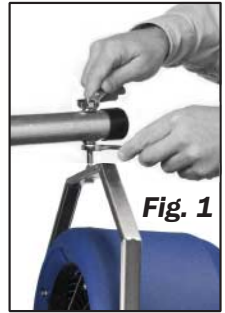

**Water Supply:** DF units come equipped with a 20-300 cc/min. (.3 - 5 GPH) Flowmeter panel. This panel should be mounted in an accessible location for monitoring and adjusting flow rate.

Cut 1/4" tubing at the desired location for the flowmeter. Connect the flowmeter to the tubing between the Hydro unit and the water supply. Use the remaining tubing and hose connector to connect to an available hose bib. To remove hose connector, apply pressure to the retaining clip while pulling on the tubing. **See Fig. 2**

**Power Supply:** Plug directly into a properly grounded receptacle.

If using a DF Control, plug the Control into the receptacle and then plug the fan into the female side of the control's pre-wired plug. **See Fig. 3**

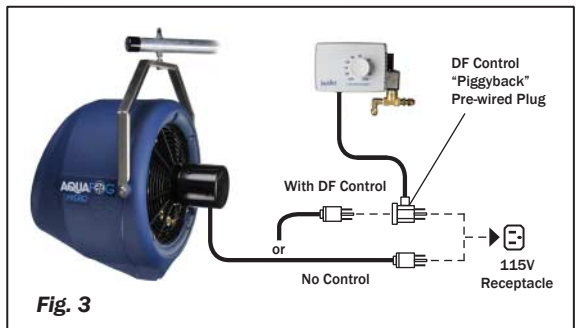
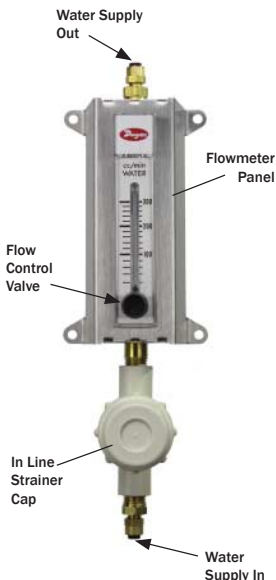
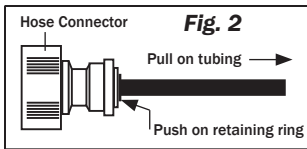

## Operation

**Adjusting fog output:** After the unit has been plugged in and the water turned on, you can adjust fogging output with the flowmeter's flow control valve. Turn counterclockwise to increase flow rate.

**Pivot Feature:** Pivot the fogging head anywhere between 15° down and 40° up from neutral. The manufacturer's recommended angle is about 30° up.

# MAINTENANCE

**Lubricate Motor:** Remove two blue plugs at the top of the motor. Apply 4-5 drops of light grade petroleum based oil at each bearing location 1 to 2 times a year or as needed. Replace blue plugs. **See Fig. 4**

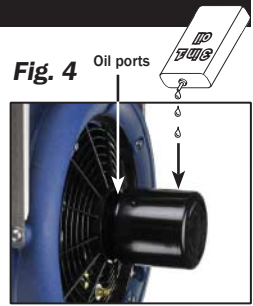

**Cleaning Blade Assembly:** After carefully removing the blade assembly, remove the stainless steel cover and O-ring. Soak the blades in CLR for about one hour, scrub clean and rinse off with water. Carefully check the small holes leading into passageways that extend the length of each blade. **See Fig. 5** When clean, test by blowing a small amount of air through each blade.

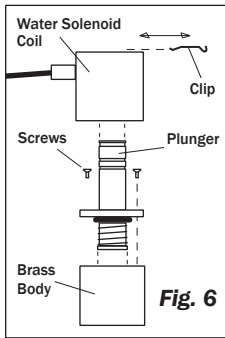
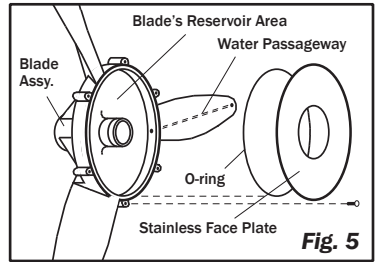

Water Solenoid from optional "DF" control packages

## Water Solenoid:

Solenoids rarely become clogged but can be disassembled and cleaned if needed. **See Fig. 6**

**Clean Strainer:** Periodically check and clean out debris that gets caught in the in-line strainer.

**Winterizing:** Protect your unit from winter damage. If storing unit in freezing temperatures, be sure all fluid is drained from the unit.

## Troubleshooting

### Possible Cause(s)

### Corrective Action

#### NO FOG

- |                             |   |
|-----------------------------|---|
| 1. Stiff/Locked Motor Shaft | 1. Lubricate motor bearings while manually rotating shaft back and forth until loose. |
| 2. Bad Motor                | 2. If motor smells, doesn't start, or shaft will not loosen up, replace motor.        |
| 3. Clogged Flowmeter Panel  | 3. Remove valve and clean. If problem recurs, clean inside the flowmeter body.        |
| 4. Clogged In-Line Strainer | 4. Remove strainer cap, screen, and O ring. Flush clean with water.                   |
| 5. Clogged Water Solenoid   | 5. Remove the top clip and disassemble the valve for cleaning with a Philips driver.  |
| 6. Clogged SST Feed Tube    | 6. Remove the ream with a small wire. Clean and reinstall.                            |

#### POOR QUALITY FOG

- |                               |   |
|-------------------------------|---|
| 1. Clogged Blade Assembly     | 1. Remove and clean out the rear reservoir and the blades' passageways.                   |
| 2. Misaligned Water Feed Tube | 2. Adjust the feed tube so its water stream flows into the the reservoir area. Resecure.  |
| 3. Stiff/Locked Motor Shaft   | 3. Lubricate motor bearings, while manually rotating shaft back and forth until loose.    |
| 4. Loose Blade Assembly       | 4. If the blade assy. can easily spin without the motor shaft spinning, replace the assy. |

#### FAN DOES NOT SPIN

- |                               |   |
|-------------------------------|---|
| 1. Stiff/Locked Motor Shaft   | 1. Lubricate motor bearings while manually rotating shaft back and forth until loose. |
| 2. Bad Motor                  | 2. If motor smells, doesn't start or shaft will not loosen-up, replace motor.         |
| 3. Bad Electrical Connections | 3. Check for loose connections, test motor and controls with a direct power supply.   |

#### MOTOR OVERHEATING

- |                             |   |
|-----------------------------|---|
| 1. Stiff/Locked Motor Shaft | 1. Lubricate motor bearings while manually rotating shaft back and forth until loose. |
| 2. Bad Motor                | 2. If motor smells, doesn't start or shaft will not loosen-up, replace motor.         |

## SERVICE & REPAIR



### Atomizing Ring/Front Guard Assembly

Using a 3/8" nut driver or wrench, remove four 10-24 flange nuts located at the back of the housing. **See Fig. 7.** Remove the guard/atomizing assembly out the front fan opening. To reinstall, it is easiest to work the bottom legs into position and finger tighten their nuts first before working the upper two legs into position.

### Fan Blade Assembly

First remove the atomizing ring/front guard assembly. The blade assembly is press-fitted onto the motor shaft. Position fingers behind both sides of the hub with forearms pressed up against the rim of the housing. Use the housing's rim as leverage and pull the blade assembly outward towards the front. **See Fig. 8** Pull primarily on the hub portion of the blade assembly; excess force on the blades can cause damage. To reinstall, press on using the palm of one hand while the other hand is supporting the unit.



**Fig. 8**

### Access to Motor

Disconnect the electrical power. After removing the atomizing ring, front guard assembly and blade assembly, use a 3/8" nut driver or wrench to remove the four 10-24 nuts behind the blade assembly securing the motor to rear guard.

**See Fig. 8**

### Cleaning Flowmeter

Using a small flat screwdriver, remove the retaining key using Slot A by sliding the key out toward the back. **See Fig. 9** Next, use the screwdriver in Slot B to pull the retainer cap straight up. After the retainer cap is removed, be careful not to lose the internal float ball when handling or cleaning the flowmeter.

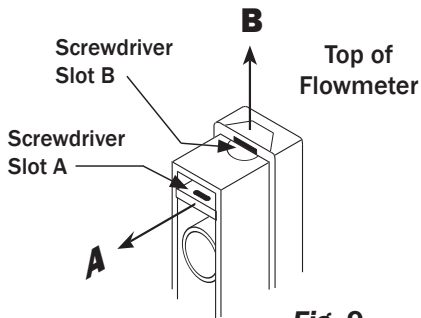

**Fig. 9**

# REPLACEMENT PART IDENTIFICATION



	DESCRIPTION	PART NO.
1	Atomizing Ring	400-001
2	Front Guard	400-002
3	Motor 1/20hp 115V	400-110
4	Rear Guard	400-127
5	Blade Assembly	400-128
6	Housing	400-100
7	Hanger Assembly	400-129
8	SST Water Feed Tube	400-130
9	Pivot Location	NA
10	Drain Barb Fitting	400-114
11	Drain Hose	400-089
12	Flowmeter Panel Assembly	SS-FP-5
13	In-Line Strainer	71
13	1/4" Water Tubing	W-14
14	Garden Hose Connect	W-2





## ONE YEAR LIMITED WARRANTY

Aquafog and accessories are warranted to the original purchaser against defects in material and workmanship under normal use for one full year from date of purchase. Any part determined to be defective and returned to the manufacturer, shipping cost prepaid, will be repaired or replaced at Jaybird Manufacturing, Inc.'s discretion without charge. Proof of purchase date and an explanation of the problem or complaint must accompany the returned portion of the machine.

Jaybird Manufacturing, Inc. reserves the right to verify the legitimacy of claimed defects. The provisions of this warranty do not apply to damage resulting from direct or indirect misuse, negligence, accident, lack of maintenance, or unauthorized repairs or alterations which affect the machine's performance or reliability.

**LIMITATIONS OF LIABILITY. TO THE EXTENT ALLOWABLE UNDER APPLICABLE LAW, JAYBIRD MANUFACTURING, INC.'S LIABILITY FOR DEATH, INJURIES TO PERSONS OR PROPERTY, OR FOR CONSEQUENTIAL OR INCIDENTAL DAMAGES ARISING FROM THE USE OF OUR EQUIPMENT IS EXPRESSLY DISCLAIMED. JAYBIRD MANUFACTURING, INC.'S LIABILITY IN ALL EVENTS IS LIMITED TO, AND SHALL NOT EXCEED, THE PURCHASE PRICE PAID. NO OTHER WARRANTY, EXPRESSED OR IMPLIED, IS AUTHORIZED, INCLUDING WARRANTIES OF MERCHANTABILITY AND FITNESS FOR A PARTICULAR PURPOSE.**

*This warranty gives you specific legal rights, and you may also have other rights, which vary from state to state.*



### **Jaybird Manufacturing, Inc.**

135 Summer Lane  
Centre Hall, PA 16828

Parts & Service: 1.814.364.1800

Website: [www.jaybird-mfg.com](http://www.jaybird-mfg.com)

Printed in U.S.A.

© 2015 Jaybird Mfg., Inc.